

FEATURES

- Field-Bus remote data acquisition
- Modbus Slave device on RS-485
- Modbus RTU/ Modbus ASCII protocol
- 8 channels 2 wires input
- Input configurable for Pt100, Pt1K, Ni100, Ni1K and resistance up to 2 K Ω
- Watch-Dog Alarm
- Remotely Configurable
- 2000 Vac 3-ways Galvanic Isolation
- High Accuracy
- UL / CE mark
- DIN rail mounting in compliance with EN-50022

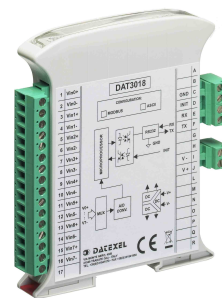

GENERAL DESCRIPTION

The DAT 3019 device is able to acquire up to 8 analogue input signals. The data are transmitted with MODBUS RTU/MODBUS ASCII protocol on the RS-485 network (RS-232 interface is available).

It is possible to connect on input 2-wires RTD sensors or up to 2 K Ω resistance sensors.

The device guarantees high accuracy and stable measure versus time and temperature.

To ensure the plant safety, two Watch-Dog timer alarms are provided.

The isolation between the parts of circuit removes eventual ground-loop effects, allowing the use of the device even in the heavy environmental conditions.

The DAT 3019 is in compliance with the Directive 2004/108/EC on the electromagnetic compatibility.

The DAT 3019 is in compliance with the Directive UL 61010-1 for US market and with the Directive CSA C22.2 No 61010-1 for the Canadian market.

The device is housed in a rough self-extinguishing plastic container which, thanks to its thin profile of 17.5mm only, allows a high density mounting on EN-50022 standard DIN rail.

COMMUNICATION PROTOCOLS

The DAT3019 is designed to work with the MODBUS RTU/MODBUS ASCII protocol: standard protocol in field-bus; allows to directly interface DAT3000 series devices to the larger part of PLCs and SCADA applications available on the market.

For the protocol instructions, refer to the User Guide of the device.

USER INSTRUCTIONS

Before to install the device, please read the "Installation Instruction" section.

If the module configuration is unknown, with device powered off, connect the INIT terminal to the GND terminal (ground), at the next power on the device will be auto-configured in the default settings (refer to the User Guide of the device).

Connect power supply, serial bus and analogue inputs as shown in the "Wiring" section.

The "PWR" LED state depends on the working condition of the device: see the "Light Signalling" section to verify the device working state.

To perform configuration and calibration operations, read the instructions in the User Guide of the device.

To simplify handling or replacing of the device, it is possible to remove the wired terminals even with the device powered.

TECHNICAL SPECIFICATIONS (Typical @ 25 °C and in the nominal conditions)

INPUT			Input Accuracy (1)	POWER SUPPLY
Input type	Min	Max		
RTD 2 wires			RTD $\pm 0.2\%$ f.s. Resistance $\pm 0.2\%$ f.s.	Power supply voltage 10 .. 30 Vdc Reverse polarity protection 60 Vdc max Current consumption 30 mA max.
Pt100	-200 °C	850 °C	Linearity (1) RTD $\pm 0.1\%$ f.s.	ISOLATION Input – RS485 2000 Vac 50 Hz, 1 min. Supply – Input 2000 Vac 50 Hz, 1 min. Supply – RS485 2000 Vac 50 Hz, 1 min.
Pt1000	-200 °C	200 °C		
Ni100	-60 °C	180 °C		
Ni1000	-60 °C	150 °C		
RES. 2 wires			RTD excitation current Typical 0.450 mA	ENVIRONMENTAL CONDITIONS Operative Temperature -10 °C .. +60 °C UL Operative Temperature -10 °C .. +40 °C Storage Temperature -40 °C .. +85 °C Humidity (not condensed) 0 .. 90 % Maximum Altitude 2000 m Installation Indoor Category of installation II Pollution Degree 2
Low	0 Ω	500 Ω	Thermal drift (1) Full scale $\pm 0.015\%$ / °C	
High	0 Ω	2000 Ω		
			Sample time 0.5 \div 2 sec.	
			Data Transmission Baud Rate 38.4 Kbps Max. distance 1.2 Km – 4000 ft	MECHANICAL SPECIFICATIONS Material Self-extinguish plastic IP Code IP20 Wiring wires with diameter 0.8 \div 2.1 mm ² /AWG 14-18 Tightening Torque 0.5 N m Mounting in compliance to DIN rail standard EN-50022 Weight about 150 g.
			Warm-up time 3 min.	
				CERTIFICATIONS EMC (for industrial environments) Immunity EN 61000-6-2 Emission EN 61000-6-4 UL US Standard UL 61010-1 Canadian Standard CSA C22.2 No 61010-1 CCN NRAQ/NRAQ7 Typology Open Type device Classification Industrial Control Equipment File Number E352854

(1) Referred to input Span (difference between max. and min. Values)

INSTALLATION INSTRUCTIONS

The DAT 3019 is suitable for fitting to DIN rails in the vertical position. For optimum operation and long life follow these instructions:

When the devices are installed side by side it may be necessary to separate them by at least 5 mm in the following case:

- If panel temperature exceeds 45°C and at least one of the overload conditions exist.

Make sure that sufficient air flow is provided for the device avoiding to place raceways or other objects which could obstruct the ventilation slits. Moreover it is suggested to avoid that devices are mounted above appliances generating heat; their ideal place should be in the lower part of the panel. Install the device in a place without vibrations.

Moreover it is suggested to avoid routing conductors near power signal cables (motors, induction ovens, inverters etc...) and to use shielded cable for connecting signals.

CABLING

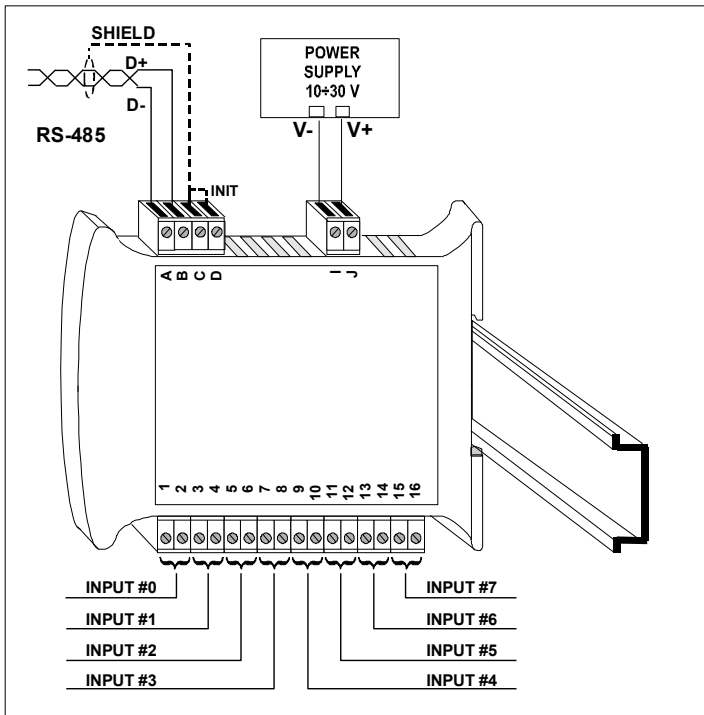

LIGHT SIGNALLING

LED	COLOUR	STATE	DESCRIPTION
PWR	GREEN	ON	Device powered
		OFF	Device not powered / Wrong RS-485 cabling.
		FAST BLINK	Communication in progress (blink frequency depends to baud-rate)
		1 second BLINK	Watch-Dog Alarm condition

MECHANICAL DIMENSIONS (mm)

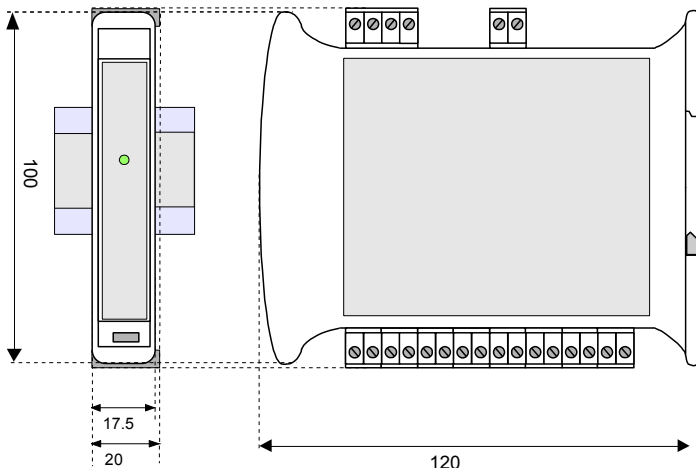

WIRING

ANALOG INPUTS

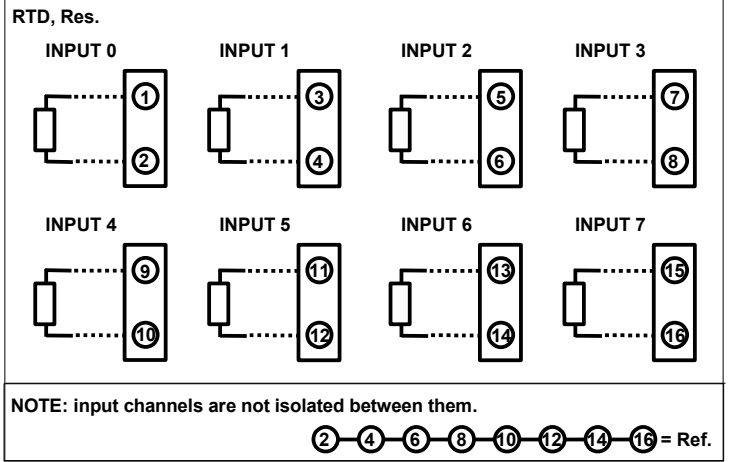

RS-485 NETWORK

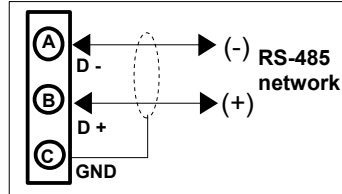

RS-232 NETWORK

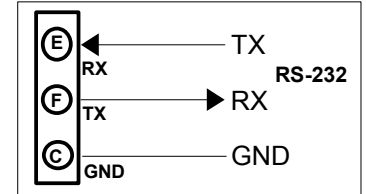

POWER SUPPLY (*)

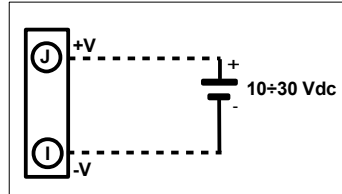

INIT

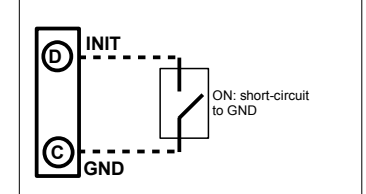

(*) Note: for UL installation the device must be powered using a power supply unit classified NEC class 2 or SELV

ISOLATION STRUCTURE

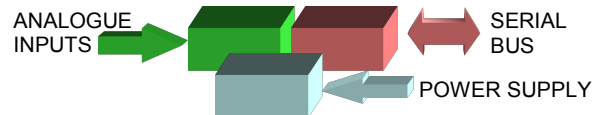

HOW TO ORDER

In the order phase, it is mandatory to specify the interface type (RS485 or RS232). DAT3019 can be supplied with the configuration specified by the customer.

ORDER CODE:

DAT 3019 / 485 / Pt100

Interface type
485 : RS-485
232 : RS-232

Input type

■ = Requested
□ = Optional